

45-48	6
30-44	1
DOOR OPNG.	T

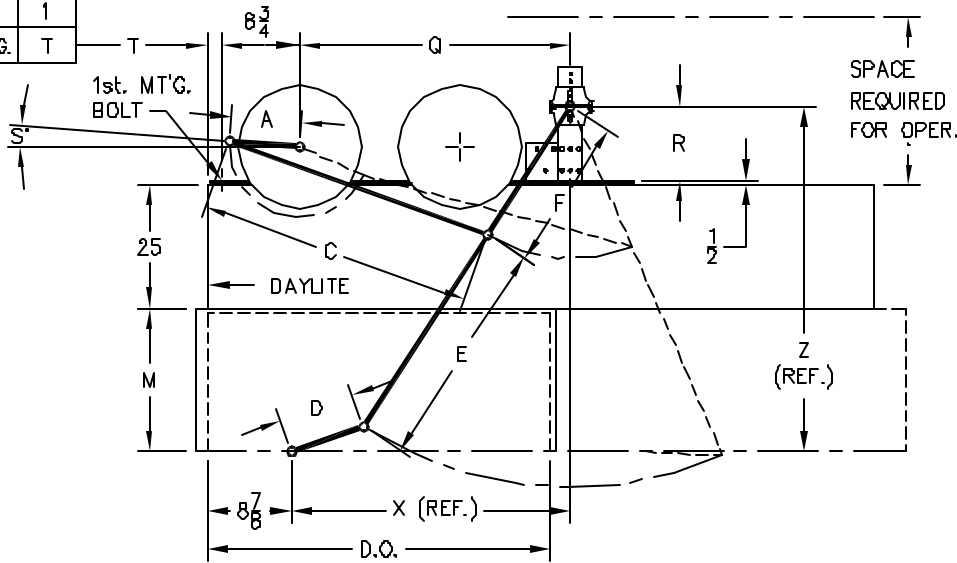

MOVFR	15
MOCT MOD	
MOM-MOH	19
MOMCT MOHCT	

48	8 3/8	34 5/8	12	41	21	23	39 5/8	59 1/4	33 1/2	10 3/4	5'
47	8 1/4	34 1/2	12	41	21	23	39 5/8	59 1/4	33 1/2	10 3/4	5'
46	8	34 3/8	12	41	21	23	39 5/8	59 1/4	33 1/2	10 3/4	5'
45	7 7/8	34 1/4	12	41	21	23	39 5/8	59 1/4	33 1/2	10 3/4	5'
44	8 3/8	36 1/8	10	34	21	19	34 5/8	52 3/8	33 1/2	7 7/8	12'
43	8 1/8	35 7/8	10	34	21	19	34 5/8	52 3/8	33 1/2	7 7/8	12'
42	8	35 3/4	10	34	21	19	34 5/8	52 3/8	33 1/2	7 7/8	12'
41	7 7/8	35 5/8	10	34	21	19	34 5/8	52 3/8	33 1/2	7 7/8	12'
40	7 3/4	35 1/2	10	34	21	19	34 5/8	52 3/8	33 1/2	7 7/8	12'
39	6 7/8	30 5/8	8	33	18	15	29 1/4	48 7/8	28 3/8	8 3/8	10'
38	6 3/4	30	8	33	18	15	29 1/4	48 7/8	28 3/8	8 3/8	10'
37	6 5/8	29 7/8	8	33	18	15	29 1/4	48 7/8	28 3/8	8 3/8	10'
36	6 3/8	29 3/4	8	33	18	15	29 1/4	48 7/8	28 3/8	8 3/8	10'
35	6 1/4	29 5/8	8	33	18	15	29 1/4	48 7/8	28 3/8	8 3/8	10'
34	5 5/8	25 3/8	6	36	15	15	25 1/4	49 1/8	24 3/8	8 5/8	5'
33	5	25 1/4	6	36	15	15	25 1/4	49 1/8	24 3/8	8 5/8	5'
32	4 7/8	25 1/8	6	36	15	15	25 1/4	49 1/8	24 3/8	8 5/8	5'
31	4 5/8	24 1/4	6	36	15	15	24 3/8	49 1/2	23 1/2	9	5'
30	4 1/2	24 1/8	6	36	15	15	24 3/8	49 1/2	23 1/2	9	5'
INCHES	A	C	D	E	F	M	X	Z	Q	R	S
DOOR OPENING	OPERATOR ARMS		DOOR ARMS			CLUTCH	PIVOT		OPERATOR		



SINGLE SPEED & TWO SPEED OPERATOR DATA TABLE
30-48 D.O. FOR HIGH CABS 25" HEADER

FEB. 23 1987

S6898-25